

# DRYERS

An endless tale of a smart evolution



# DRYERS

- 03 - Wavy interface
- 05 - Cloud
- 06 - GD Wavy dryers
- 08 - Features – GD Wavy dryers
- 10 - GDZ G-Wiz<sup>®</sup> dryers
- 12 - Features - GDZ G-Wiz<sup>®</sup> dryers
- 14 - Market
- 16 - Sustainability
- 18 - Technical files

# The intelligence at your fingertips has a name: Wavy!



**Intuitive, touchscreen and multi-level interface that offers simple, quick and Step-by-Step procedures. Everything is measured according to the user needs and skills.**

## **A simple, modern and interactive interface**

Wavy is a new, user-friendly, interactive and touchscreen graphic user interface, that provides information for programming and monitoring our machines in a visual way. Inspired by the high-tech world, Wavy exploits the potential of the app language, to make faster and easier your daily work in a laundry. It's a control system that speaks your language, not only in the literal sense, but because adapts itself to the level of users experience! The access, indeed, is hierarchical so everything is dosed on the type of user (basic, intermediate, professional or technical) and the procedures are simple and Step-by-Step.

## **WAVY is fast, dynamic and catchy**

We've chosen Wavy because it's an international name, short, easy to pronounce and remember. A catchy name, then, that reflects the essence of our new control system that's fast, dynamic and easy to use. Also the logo is the result of a particular choice: is the stylisation of a finger pressing an app. Name and visual together, then, briefly explain the modernity of our path. In the last few years or society has changed: words like app, mobile, social and cloud are now part of our daily language. So, in this new scenario, we felt the necessity to change image and language, offering a proper answer to the new requirements of our clients. And the answer is Wavy!

## **We welcome the 2.0 revolution in the laundry world!**

Easy as a tablet, which follows the appearance, this new interface will revolutionise your job in the laundry, simplifying it further. Just two clicks and you've started the washing machine! But there's more, also the update is easy. Update the software is as simple as downloading an app on your smartphone!





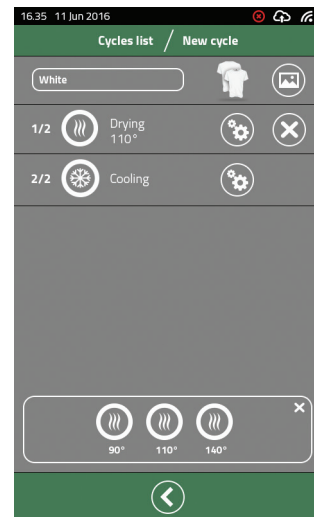
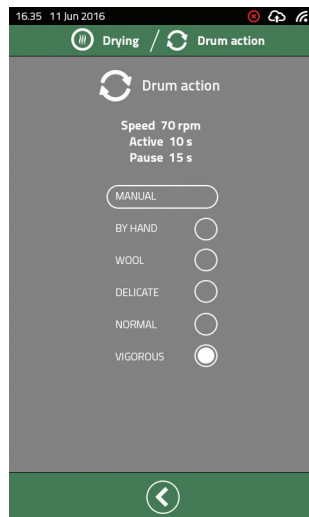
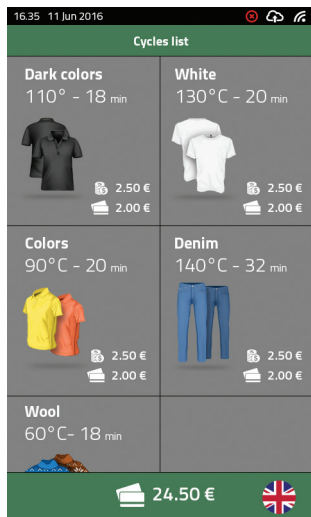

## Self-service user

This kind of user can choose only the pre-set program according to the type of laundry to be treated. The procedure is simple and completely visual: through graphical icons, the interface allows to select just the kind of clothes (jeans, dark clothes, delicate, colorful, whites, etc.) and, before starting, the payment method, of course. The progress of the cycle is visible on the display and the user will only have to worry about going back to take his clothes at the end.

## Professional user

The professional user, with a deep knowledge of the laundry industry, has a free access to every parameters and, therefore, a complete control of the machine. He can modify or create new programs for specific needs (type of fabric, water, detergents, etc.), but also view the archive of machine operation (cycles performed, consumption, receipts, etc.).

## Basic user

Just like the previous one, except for the selection of the payment method, the basic user can choose, in two clicks, only the type of laundry to be washed. Our machine does the rest.

## Technical user

Since this kind of user is usually a maintainer or a dealer, with a deep experience and knowledge of our washing machines, he has a 360° access to the equipment. He can modify the operating parameters, access the archive, the data on consumption and, especially the data log.

## Intermediate user

Equipped with a greater knowledge of cleaning process, the intermediate user is able to make some changes to the pre-set programs, such as increases the temperature, removes the pre-wash, sets the fast forward, etc. But he hasn't the license for creating new washing programs.

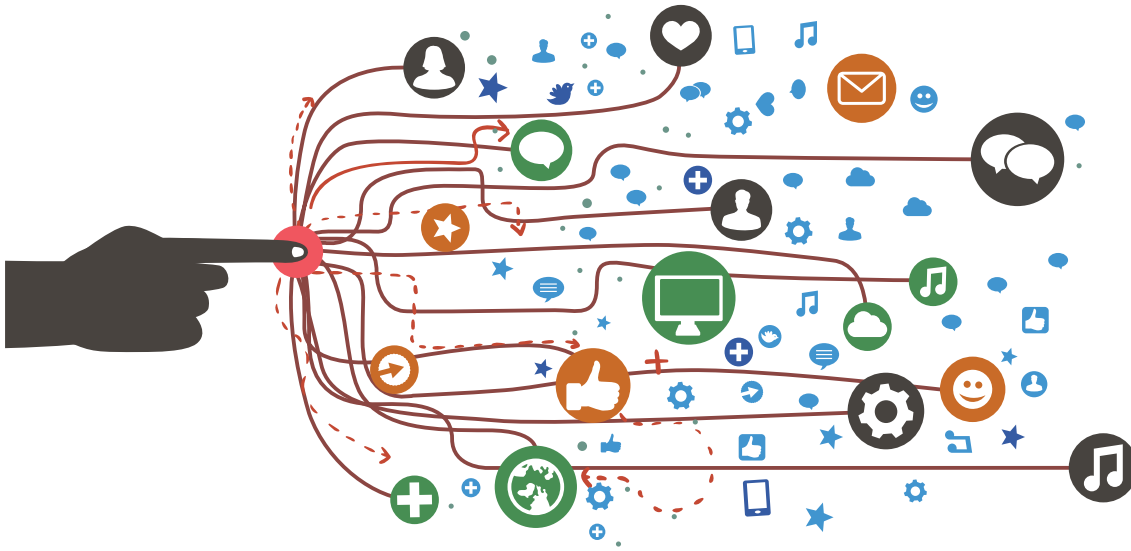

### **A gentle touch in the drying process**

Whit Wavy you can dry also delicate clothes, like a sweater of cashmere, without problems thanks to the presence of a management system able to manage crucial drying parameters. Such as the drum rotating speed and the suction fan rotation. The control allows, also, to monitor the fluff filter, sending notifications when it's time for maintenance.

### **It's handy like a smartphone**

The 7-inch display is vertical, just like your smartphone: we know that the users usually interact with this type of tools. Why should we ask them to change habits? But there's more. The display has a tempered glass (not a plastic film) and also a catchy design: we are Italian and style, quality and aesthetics are intrinsic elements of our DNA. So we don't just create useful tools, we also make them beautiful.

### **It's time to touch!**

Say goodbye to the instruction manual and lengthy procedures to set the parameters of the machine. With Wavy each step is simple and clear. Setting the temperature or the duration of the cycle is possible just clicking on an app. Like on your tablet or phone. Same thing for the adjustment of the engine and any other parameters.

### **Data archive always available inside the machine**

My machine is connected via Wi-Fi, the data are stored in the Cloud in order to be available everywhere, anytime. But, what would happen to the data in case of disconnection? You don't have to worry, each device has its own internal archive: the machine collects the data and send them to the Cloud. So you will never lose the information!

### **There are no limits to the number of programs**

As you certainly know, often in a tender for a contract, one of the parameters used to win the competition is the number of programs that the device is able to offer. Thanks to the Cloud service, it no longer makes sense to specify that number, because there are no limits. Within the Cloud it's possible to host a growing number of programs.

### **Close connection between hardware and software**

Unlike the majority of companies, we've developed hardware and software together to avoid any compromise in performance or usability problems. In this way the two souls of our new equipment are closely bond.

### **Wi-Fi connected: your passport to the world**

The idea of creating a control system connected via Wi-Fi to the Cloud is not a fleeting trend or a whim, it's the only solution to really be in step with the new expectations of customers and, above all, to cut costs and make faster and easier the laundry activity. We have created a social device for "social animals", because we believe that the future of the professional industry is also connection.

### **The entire laundry always under control**

Why choose an advanced and performing dryer like GD Wavy for setting few parameters? Since a laundry is a complex set of equipment that synergistically work together, it wouldn't have any sense having a washing machine connected to the Cloud and, instead, a dryer with a different system that requires a control on site. Equipping a laundry with appliances that speak the same language with the users and among themselves, means to control the job in a smarter, coordinate and easy way.

# Everything is connected on WavyCloud!



**It's a neural network of know-how, processes and diagrams with a hierarchical access (user, operator, administrator). Contents and resources are always available and it's easy managing and monitoring the equipment from everywhere in the world, anytime!**

## Control is just a click away!

Without moving from everywhere, WavyCloud allows you to monitor operation and performance of one or more machines and structures (laundry, self-service, condominium, hospital, etc.). It's perfect to control your business anytime you need and, above all, to planned the workflows. Thanks to the Cloud service, indeed, you can check the operating parameters of the machine (type and number of cycles performed, consumption, hours of operation, cycle traceability, costs and receipts). But there's more, the system allows to make queries by serial number, model, customer and structure, or to see a synoptic of the laundry, showing the situation in real time (busy/free machines, remaining cycle time, standby, etc.). You can also set a message alert to warn you when a washing drying cycle is finished! Everything is really under control with a fingertip!

## A virtual technician always available

You don't have to worry about any anomalies because even the diagnostics is managed by WavyCloud! The system deals with the detection of the equipment operation, reporting (to one or more users) any problems and failures. If the anomaly is simple (not mechanical failures) is possible resolve it directly through WavyCloud. The administrator, eventually, can stop the dryer, simply by a click. And what about the upgrade? Our system warns you about each new release, you just need to click for install it. Easy-peasy like downloading an app on your smartphone! Furthermore, it provides maintenance warnings through graphic notifications, that indicate clearly and in time the need for intervention in specific parts of the machine.

## More time for the real business

WavyCloud allows also an easier management of the administrative part of the laundry activity, with a significant reduction of times and full-time staff required for the control. The system allows, indeed, the remote monitoring of the operation data of single equipment or structure (cycles performed, consumption, operating hours, standby, receipts, etc.) and the setting of the accounting values (cycle cost and power costs, etc.) in order to have always under control the costs and the benefits. Thus, this system allows a quick and easy management of non-tax accounting.

## The best solution for every need

Every industry has its own needs and WavyCloud has the right answer for each one. For example, the monitoring and management features are perfect for the self-service industry. While, for the professional laundries it's downloading special programs for specific or delicate fabrics (e.g. wool, Gentlewash®). Health centers, food and pharmaceutical industries can use, instead, the HACCP traceability system to ensure maximum hygiene and the compliance with the regulations. The fire brigade sector meets its particular needs by downloading specific drying programs for technical fabrics. Finally, every sector due to the data archive, is able to program a more efficient and effective workflows.

## Online manuals, certificates and guides

Have you lost the instruction manual or do you need the installation scheme? Don't worry it's all available on WavyCloud. You can consult all the documents, without problems, directly on Cloud. The access to the content archive is hierarchical (user and service) so everyone can quickly see just what he needs. Moreover, you can also find an useful quick html guide.

## The winning performances now are rented!

Today customer seeks to get high quality results, not the mere possession of goods. That's why our equipment allow a pay-per-use service: hotels, health centers, marinas, campgrounds and condominiums can benefit of our equipment simply renting them, without worrying about the maintenance or replacement of the models, and paying only when they're used. This opens new business opportunities, in which the center of the sale is the service. Anyone who rents, through a specific menu, has the entire control over the equipment: from the diagnostics to the performances, from the maintenance to the number of cycle performed until the state of payments. WavyCloud, in the pay-per-use configuration, allows the remote management of licenses, utilities and deadlines and, if necessary, even stops the machine. The user, however, has the benefit of using the latest technology without large investments or specific skills.

# GD Wavy Dryers: new face, same reliability

**A renewed design and an innovative interface,  
combine with the proven mechanical, functional and  
performance qualities of the Grandimpianti machines.**

## Always dried to perfection!

Thanks to the drying diagram Wavy dryer adjusts itself progressively, according to the type of load and the level of drying. No more a simple countdown at a set temperature, then, but three phases of a process that regulate the intensity and the duration according to the humidity of the fabrics. Furthermore, the device requires about 1 kW per kilogram of linen, with a low environmental impact, it fully exploits the hot incoming air, so as to never exceed 50° C at the exhaust.

## Powerful when you need it

Wavy dryers can work with three types of heating: gas, electric or steam, so that to better adapt to each requirements. The gas models (and the 450÷600 models electric heated ones) have a special two stages heating system that is wholly or partially activated, according to the necessity: when the hot air inside the drum has reached the selected temperature, the heating system is only partially activated. The maximum power is reached only when it's really necessary, this guarantees a lower environmental impact and reduces the energy consumption.

## New Italian design

Beauty and functionality. Aesthetics and ease of use. Design and ergonomics. This principles are crucial even in our new drying machines. With a completely renewed design, GD Wavy tumble dryers are made with meticulous attention to details. The size of the portholes, the tempered glass, the shiny fronts, the vertical 7-inch display, everything reply to specific ergonomic and aesthetic criteria. To guarantee further insulation, the porthole and the filter inspection door are equipped with special EPDM® rubber gaskets. Reducing the loss of heat means more effective and faster drying and greater savings.

## It's a virtuous circle!

Reducing the heat dispersion allows to ensure a perfect drying of clothes. This is the reason why we no longer equip our machines with the traditional crosspiece bottom but with a drum made of printed material and also, we've reduced the space between tub and drum. The drum of the Wavy dryers is also insulated inside a ceramic fibre tank: the same material used in professional ovens.

## We focus on safety

Like every other Grandimpianti appliances, also our Wavy dryers have double safety systems and redundant alarm circuits like airplanes. In the unlikely event that a protective device fails, its double is immediately activated to guarantee the safety.

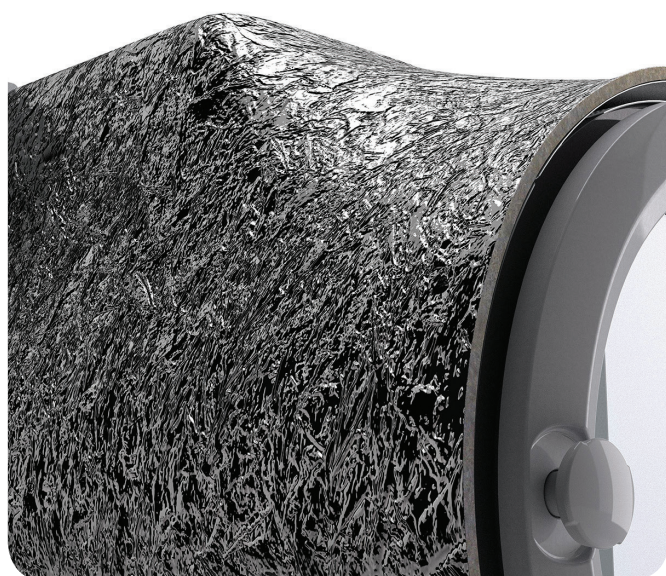



### Costs optimization

It reduces consumption thanks to the thermal insulation. Drum and air ducts are thermally insulated to reduce the heat loss and make the most of the warm air. Furthermore, to achieve a more efficient drying, the air follows a direct path, without vortices.



### Time saving

It saves time with the drying diagram. The drying steps runs, as the cycle progresses, time and temperature in three separate steps. It will save you up to 12 minutes each cycle, that allows to run about additional 3-4 cycles every 8 hours.



### Low noise level

Sssst! Only 54dB of acoustic emission. GD Wavy dryers have a low noise impact. This means more comfortable use and less impact on the surrounding environment.



### Recycling rates

92% of recyclability rate. It's an eco-friendly dryer until its disposal. Our machine is made almost completely of recyclable material, such as PVC (skinplate), and therefore has low environmental impact even when you decide to change it.



### High quality materials

It required less maintenance thanks to the high-quality materials selected. The gas dryers, for example, have titanium burners that withstand high temperatures. The electric models use tubular resistances made of anti-clogging INCOLOY® steel. In the steam dryers the heating coils are protected by filters made of steel that block the dust. Finally, the gaskets made of EPDM® rubber and the long-lasting belts ensure efficacy over time.



### Usability

It assures an ease of use thanks to the porthole with a wide opening. The dryers have a strictly ergonomic design: the large porthole ensures an ease and speed loading and unloading of the laundry. Less wasted time and more attention to the user.



# Innovative dryers with a soul

## Details make the difference!

Let's get down to the details of the innovative GD Wavy dryers to appreciate the newness that makes this product great. New design and ergonomics are combined with the traditional features of Grandimpianti appliances. This short tour, through the most representative details, gives us a quick overview of its aesthetic and functional characteristics.



**A.** Double protection. GD Wavy tumble dryer has a safety thermostat placed at the exhaust to always monitoring the flue temperature, in addition to the adjustable T2 managed directly by Wavy control.



**B.** Long-lasting EPDM® rubber gaskets on the porthole. Avoids the dispersion of hot air, thus ensuring greater efficiency and lower energy consumption.



**C.** The powerful fan, placed in an air spiral with an innovative design, ensures fast, fluid and silent air flow to the outside.



**D.** The special long-lasting hinges with integrated and redundant micro switches, guarantee the reliability of the porthole up to a million of closures, removing the need for maintenance.

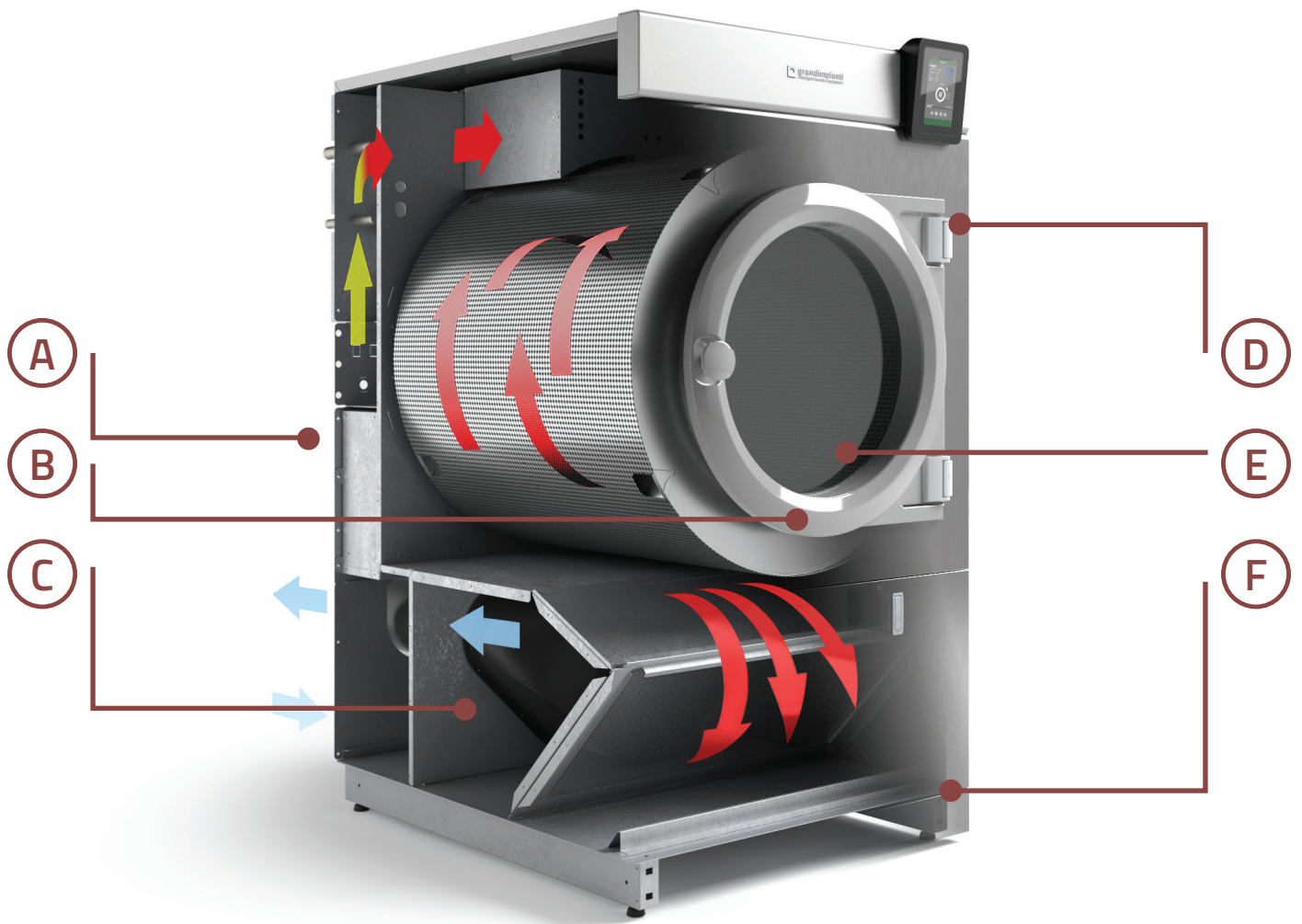

**E.** The wide porthole which opens up to 180° allows an easy loading and unloading of the laundry. The EPDM® rubber gaskets ensure a tight closure.



**F.** The cleaning door of the filter is sealed with a triple-lip of EPDM® rubber gasket: no leakage of air, no heat dispersion and an exceptional low noise emissions.



# GDZ G-Wiz® the entry level dryers

Developed in 2012, these dryers was our first step toward the creation of smart devices able to communicate with the user, using his language, and simplify the job in the laundry.

## Precision drying. Standard!

The dryer adjusts its actions progressively according to the type of load and the degree of drying achieved. The dryers GDZ G-Wiz® can thus respond to different working conditions thanks to the drying diagram - innovation that Grandimpianti i.l.e. has introduced on its machine since 2008 - which is a dynamic process. The device requires about 1 kW per kg of linen, with a low environmental impact, exploiting fully the hot incoming air, so as to never exceed 50° C at the exhaust.

## Do not escape!

Reducing the heat dispersion allows to dry better the laundry, a drum bottom without the traditional crosspiece but made of printed material as well as the reduction of space between the tub and drum prevents the leakage of hot air. The drum of Grandimpianti dryers is further insulated inside a ceramic fibre tub: the same material used in high-temperature ovens. To guarantee further insulation, the porthole and the filter inspection door are equipped with special EPDM® rubber gaskets. Reducing the loss of heat means more effective and faster drying and greater energy savings.

## Double!

GDZ G-Wiz® dryers are equipped with double safety devices and redundant alarm circuits. Like on airplanes. In the unlikely event that a protective device fails, its double is activated to guarantee the safety.

## Italian Design

The entry level drying machines are made with meticulous attention to detail, even in terms of their external appearance. The sizes of the portholes, the tempered glass, the rounded edges, the size of the machines have all been designed for convenient and efficient use of the dryer, optimising its overall.

## Intense as needed

GDZ G-Wiz® dryers can work with three types of heating: gas, electric or steam. The gas model (and the 450÷600 models electric heated ones) has a special two stages heating system that is wholly or partially activated according to the necessity. Essentially, when the hot air inside the drum has reached the set temperature, the heating is only partially activated. The maximum power is reached only when it's really necessary. This guarantees a lower environmental impact and reduces energy consumption.

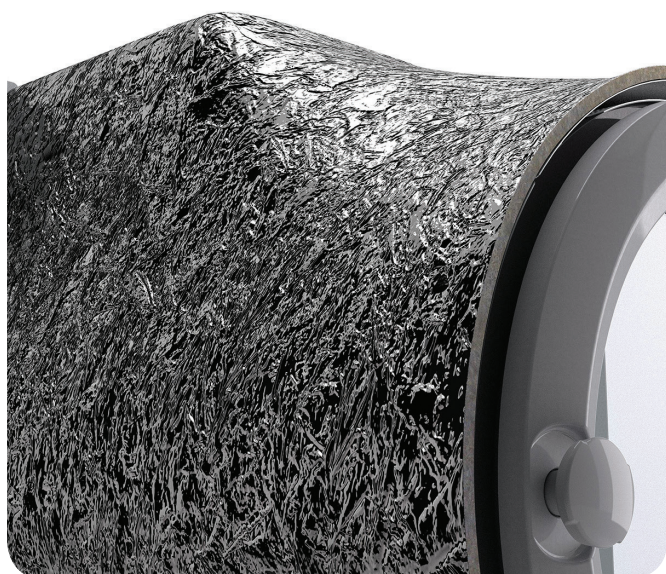





### Costs optimization

It reduces consumption thanks to the thermal insulation. Drum and air ducts are thermally insulated to reduce the heat loss and make the most of the warm air. Furthermore, to achieve a more efficient drying, the air follows a direct path, without vortices.



### Time saving

It saves time with the drying diagram. The drying steps runs, as the cycle progresses, time and temperature in three separate steps. It will save you up to 12 minutes each cycle, that allows to run about additional 3-4 cycles every 8 hours.



### Low noise level

Sssst! Only 54dB of acoustic emission. GDZ G-Wiz® dryers have a low noise impact. This means more comfortable use and less impact on the surrounding environment.



### Recycling rates

92% of recyclability rate. An eco-friendly dryer until its disposal. Our machine is made almost completely of recyclable material, such as PVC (skinplate), and therefore has low environmental impact even when you decide to change it.



### High quality materials

It required less maintenance thanks to the high-quality materials selected. The gas dryers, for example, have titanium burners that withstand high temperatures. The electric models use tubular resistances made of anti-clogging INCOLOY® steel. In the steam dryers the heating coils are protected by filters made of steel that block the dust. Finally, the gaskets made of EPDM® rubber and the long-lasting belts ensure efficacy over time.



### Usability

It assures an ease of use thanks to the porthole with a wide opening. The dryers have a strictly ergonomic design: the large porthole ensures an ease and speed loading and unloading of laundry. Less wasted time and more attention to the user.

# Entry level dryers with a soul

## The details count!

Let's get down to the details of the GDZ G-Wiz® dryers. We see the soul of our entry level dryers to appreciate the technical features that make this product great. A quick look at the most representative details gives us an overview of the aesthetic and functional characteristic of these equipment.



**A.** Double protection. GDZ G-Wiz tumble dryer has a safety thermostat placed at the exhaust to always monitoring the flue temperature, in addition to the adjustable T2 managed directly by G-Wiz control.



**B.** Long-lasting EPDM® rubber gaskets on the porthole. Avoids loss of hot air, thus ensuring greater efficiency and lower energy consumption.



**C.** The powerful fan, placed in an air spiral with an innovative design, ensures fast, fluid and silent air flow to the outside.



**D.** The special long-lasting hinges with integrated and redundant micro switches, guarantee the reliability of the porthole up to a million of closures, removing the need for maintenance.





**E.** The wide porthole which opens up to 180° allows an easy loading and unloading of the laundry. The EPDM® rubber gaskets ensure a tight closure.



**F.** The cleaning door of the filter is sealed with a triple-lip of EPDM® rubber gasket: no leakage of air, no heat dispersion and an exceptional low noise emissions.

# Grandimpianti listens to the market



**We've always listened to our customers:  
today they're asking speed, connectivity and convenience.  
Our answer is an innovative solution that makes  
their job smarter, faster and easier.**

## Machines ready to go everywhere!

Listening, observing and analysing the market is crucial for us! We've always been opened to the world! This inclination has helped us to develop versatile and innovative machines, ready for different environments, industries and geographic areas: from small restaurant to large offshore platform, from food industry to cruise ships, from hospitals to self-service laundries and much more. But, above all, they are prepared to be always connected and easily managed from everywhere, anytime you need!

## National and international regulations

Collecting, analysing and developing the customer requirements is the vision that permit us to create solutions ready for sharing with a wider network of intelligences: the market. This also leads our solutions to conform to the international standard regulations (extra-UE included): we respect the safety and the environmental protection rules, therefore, our machines are ready for all markets and countries.





**A very complex target market that includes:**



Hospitality industry



Professional laundry with Gentlewash® system



Nursing homes

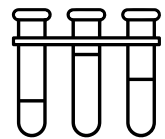

Pharmaceutical industry



Mining camps



Oil facilities



Health service



Industrial laundry



Dairy sector



Multi-Housing & self-service laundry (My Clean Clean)

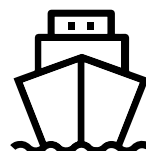

Ships & marine transports



Catering service & restaurant



# Sustainability + Safety



## Eco-friendly soul

With the drying diagram, the tumble dryer adjusts itself to the variation of laundry weight that progressively dries, this reduces the wear of the fabric and the consumption of the equipment. The maximum exhaust temperature is only 50° C: a low environmental impact. The two stage heating system starts automatically when the set temperature is reached, so as to consume only what is needed. The structure of the drum guarantees stability and reduces the dispersion of hot air, thanks to the door with gaskets made of long-lasting EPDM® rubber. The drum is, then, insulated inside a tub covered with ceramic fibre to optimise the resources as much as possible. The efficiency of the machine remains high over time because the resistances made of INCOLOY® steel prevent the deposit of fluff, the titanium burners withstand high temperatures and thermal expansion and the suction system always guarantees an effective discharge of fumes. The dryer also ensures low noise: only 54dB! Finally, the machine doesn't require pallets in order to be moved and has a recyclability of 92%.

## Ergonomic look

Both the GD Wavy and the GDZ G-Wiz® dryers are produced with 4 different capacities. The load capacity is 1:1 with GWH washing machines, in order to facilitate the combined use of these devices. In this way the entire load of laundry in the washing machine can be moved immediately inside the dryer with the same capacity: no more downtime! The door opens up to 180° and its width allows to comfortably load and unload the laundry. The door is also placed in ergonomic height so as the trolley can be placed directly in front of the equipment, making the operation of loading/unloading even faster and easier. The coin acceptor is integrated aesthetically and functionally in the dryer to facilitate the operation of self-service payment. Our dryers can also perform finishing operations to offer a truly complete service. Finally, the quietness of the machine (54dB) ensures a better working environment to the user.

## Easy installation

The dryers are designed to be easily installed and transported also through the doors. The size of the slim and lightweight frame, allows for the installation of multiple dryers side by side, possibly combining with washing machines of the same capacity. The dryers are designed to be installed by a single person. Every dryer's components are certified according to international standards.



## Easy maintenance

The long-lasting bearings don't require maintenance (they are tested to withstand more than 12,000 drying cycles) and their position allows a quick and easy replacement. Even the anti-fluff filter (made of fine gauze sacks or stainless steel mesh) is easy to clean and replace. Moreover the long-lasting gaskets, the hinges of the door - also long-lasting (up to 1 million of openings/closures) - and the anti-clogging resistances also reduce the need of maintenance. There is no maintenance access from the sides, so you don't waste time in moving the dryer: everything is accessible only from the front or the back of the machine.

## Safety is not an optional

The tempered glass door is safe and the external panels, in contact with the user, are never hot, just as well as the discharge duct. The machine has double protection systems and redundant alarm circuits, in addition to the sensor of rotation of the drum which stops the heating when the drum doesn't turn. Safety is further increased by various anti-overheating solutions, particularly useful in the gas dryers. Everything is certified according to the strictest international standards by an accredited laboratory.

## Our experience at your disposal

International standards require a 1:25 load ratio or 1 kilogram of laundry in an air volume of 25dm<sup>3</sup>. But different ratios are still used in many countries such as 1:20 or even 1:18. We adopt as a reference the international regulatory standards, but it doesn't affect the operation of the machines in other conditions. We know that fabric conditions continually change during the drying, depending on both the type and the quantity of fabric: drying is thus not only heating air. that's why we've introduced the concept of a drying diagram in order to respond to this problem, a dynamic process in which the dryer continuously adapts its parameters to the real needs.

## The drying cycle: a constantly changing process

The fabric, during the drying process, gradually changes its weight because it's losing water. In addition, heating requires a lot of resources in the beginning, when the laundry is cold and wet, but fewer resources later, when it's heated. This tells us that it's possible to effectively dry the fabrics, balancing the consumption over the time, paying careful attention. To do this, we've introduced the drying diagram. The dryers adapt themselves to the weight, humidity and temperature variation, that happen during the process. When the exhaust temperature increases (red line) the drum speed decreases (blue line) so that the laundry can easily float inside the drum and be constantly invested by the hot air generated. The machine consumes only what is needed while saving time, energy and, above all, the environment.

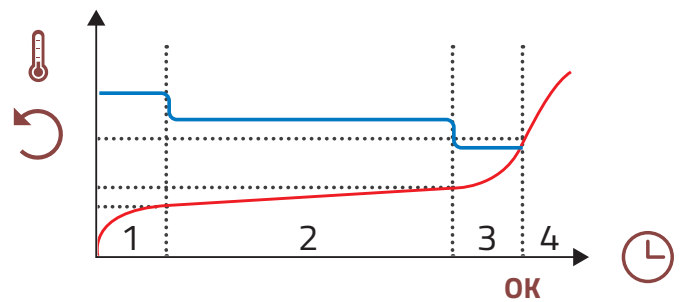

\* The nominal load capacity was calculated in accordance with ISO 9398 which provides for the loading of dry terry cotton fabric weighing 420g/m<sup>2</sup> and measuring 60cm x 90cm.

\*\* Data referred to the machine loaded with laundry of the previous \* washed and spun with a maximum residual moisture of 50%.

\*\*\* The highlighted evaporation capacity is about the correct programming of the stages of drying with linen as the previous points \* and \*\*. For other configurations the results could be different as the G-Wiz® cannot regulate itself but it depends on operator set up.

CHARACTERISTICS	GD275 / GDZ275	GD350 / GDZ350	GD450 / GDZ450	GD600 / GDZ600
Drum volume (dm <sup>3</sup> )	275	350	450	600
Load capacity (kg) *	11	14	18	24
Number of programs	No limit/10	No limit/10	No limit/10	No limit/10
Suction power (m <sup>3</sup> /h)	800	900	1200	1500
Ideal with	GWH105	GWH135	GWH180	GWH240

### ELECTRIC HEATING\*\*

Evaporation capacity (l/h)***	7.67	9.76	12.55	16.8
Power consumption (kWh)	7.35	9.75	12.6	17.4
Cycle duration (min)	43	43	41	40

### GAS HEATING\*\*

Evaporation capacity (l/h)***	8.7	12	14.21	20.6
Power consumption (kWh)	0.5	0.5	0.5	0.5
Cycle duration (min)	38	35	38	35

### STEAM HEATING\*\*

Evaporation capacity (l/h)***	8.25	9.76	13.5	16.74
Power consumption (kWh)	0.5	0.5	0.5	0.5
Cycle duration (min)	40	43	40	43

# Let's take the measurements

CHARACTERISTICS	GD275	GD350	GD450	GD600
Capacity ratio 1:25 / 1:20 / 1:18 kg*	11 / 14 / 15.3	14 / 17.5 / 19.5	18 / 22.5 / 25	24 / 30 / 33.3
Noise level (dB)	<55	<55	<55	<55
Control	Wavy			
Inversion / variation in speed	Standard			
Basket material	Aluminium coated / STAINLESS STEEL			
Air filtering mode	STAINLESS STEEL mesh			
Type of transmission	Belts with inversion / Belts with inversion and speed variator / Direct DRIVE with inversion and speed variator			
Motor power without inversion (kW)	0.75 (vacuum + drum)	0.75 (vacuum + drum)	1.1 (vacuum + drum)	1.1 (vacuum + drum)
Motor power with inversion (kW)	0.75 (vacuum) 0.37 (drum)	0.75 (vacuum) 0.37 (drum)	1.1 (vacuum) 0.55 (drum)	1.1 (vacuum) 0.55 (drum)
Motor power direct drive (kW)	0.75 (vacuum) 0.37 (drum)	0.75 (vacuum) 0.37 (drum)	1.1 (vacuum) 0.75 (drum)	1.1 (vacuum) 0.75 (drum)
Payment systems	Simple coin operation / Electronic coin operation / Payment system / Other systems available upon request			
Electric power (kW)	10,5/15	10,5/15	21/30 double stage	21/30 double stage
Gas power (kW)	13-18 double stage	13-18 double stage	16-24 double stage	16-24 double stage
Steam power (kW)	15	15	25	25
Power supply	220-240V 1~ 50/60Hz 230-240V 3~50/60Hz <b>380-415V 3N 50/60Hz</b> 440-480V 3~ 60Hz		230-240V 3~50/60Hz <b>380-415V 3N 50/60Hz</b> 440-480V 3~ 60Hz	
Net/gross weight without inversion (kg)	205 / 215	205 / 215	276.5 / 291.5	296 / 311
Net/gross weight with inversion (kg)	215 / 225	225 / 235	286.5 / 301.5	306 / 321
Porthole diameter (mm)	612	612	612	612

Provide GFCI (differential switch) Class "B" once the appliance is installed.

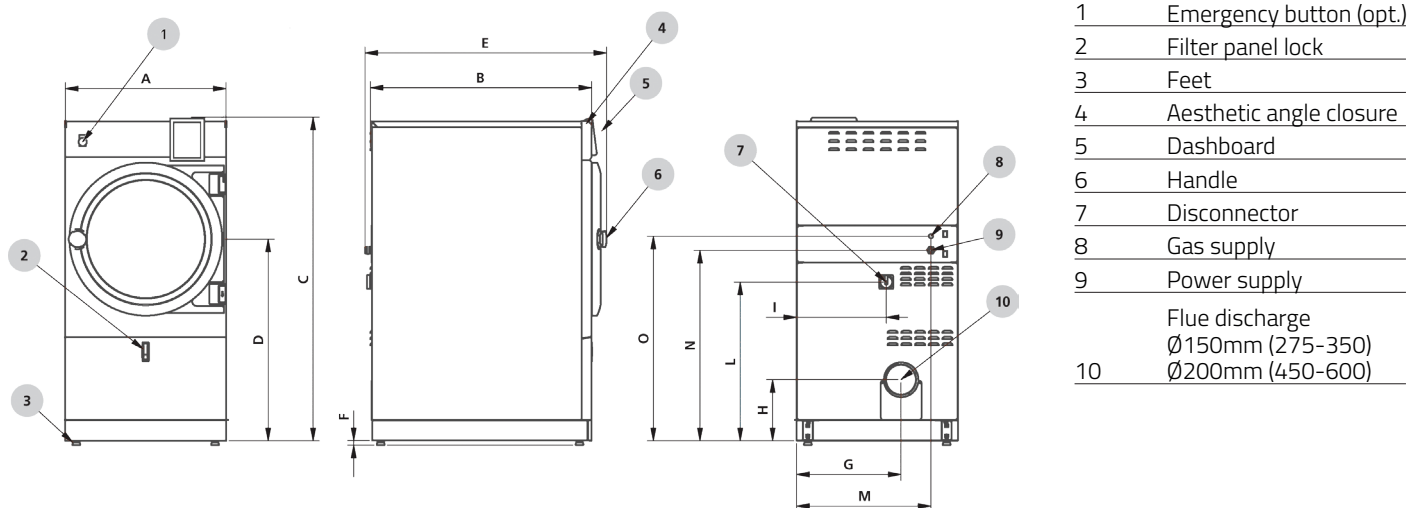

	A	B	C	D	E	F	G	H	I	L	M	N	O
GD275 (mm)	795	920	1590	1000	1030	25	515	300	442	780	563	938	1008
GD350 (mm)	795	1085	1590	1000	1195	25	515	300	442	780	563	938	1008
GD450 (mm)	970	990	1810	1090	1100	25	710	430	617	880	790	1030	1080
GD600 (mm)	970	1205	1810	1090	1315	25	710	430	617	880	790	1030	1080
	Width	Depth	Height										



CHARACTERISTICS	GDZ275	GDZ350	GDZ450	GDZ600
Capacity ratio 1:25 / 1:20 / 1:18 kg*	11 / 14 / 15.3	14 / 17.5 / 19.5	18 / 22.5 / 25	24 / 30 / 33.3
Noise level (dB)	<55	<55	<55	<55
Control	G-Wiz®			
Inversion / variation in speed	Optional / Optional			
Basket material	Aluminium coated / STAINLESS STEEL			
Air filtering mode	STAINLESS STEEL mesh			
Type of transmission	Belts without inversion / Belts with inversion / Belts with inversion and speed variator / Direct DRIVE with inversion and speed variator			
Motor power without inversion (kW)	0.75 (vacuum + drum)	0.75 (vacuum + drum)	1.1 (vacuum + drum)	1.1 (vacuum + drum)
Motor power with inversion (kW)	0.75 (vacuum) 0.37 (drum)	0.75 (vacuum) 0.37 (drum)	1.1 (vacuum) 0.55 (drum)	1.1 (vacuum) 0.55 (drum)
Motor power direct drive (kW)	0.75 (vacuum) 0.37 (drum)	0.75 (vacuum) 0.37 (drum)	1.1 (vacuum) 0.75 (drum)	1.1 (vacuum) 0.75 (drum)
Payment systems	Simple coin operation / Electronic coin operation / Payment system / Other systems available upon request			
Electric power (kW)	10,5/15	10,5/15	21/30 double stage	21/30 double stage
Gas power (kW)	13-18 double stage	13-18 double stage	16-24 double stage	16-24 double stage
Steam power (kW)	15	15	25	25
Power supply	220-240V 1~ 50/60Hz 230-240V 3~50/60Hz <b>380-415V 3N 50/60Hz</b> 440-480V 3~ 60Hz		230-240V 3~50/60Hz <b>380-415V 3N 50/60Hz</b> 440-480V 3~ 60Hz	
Net/gross weight without inversion (kg)	205 / 215	205 / 215	276.5 / 291.5	296 / 311
Net/gross weight with inversion (kg)	215 / 225	225 / 235	286.5 / 301.5	306 / 321
Porthole diameter (mm)	612	612	612	612

Provide GFCI (differential switch) Class "B" once the appliance is installed.

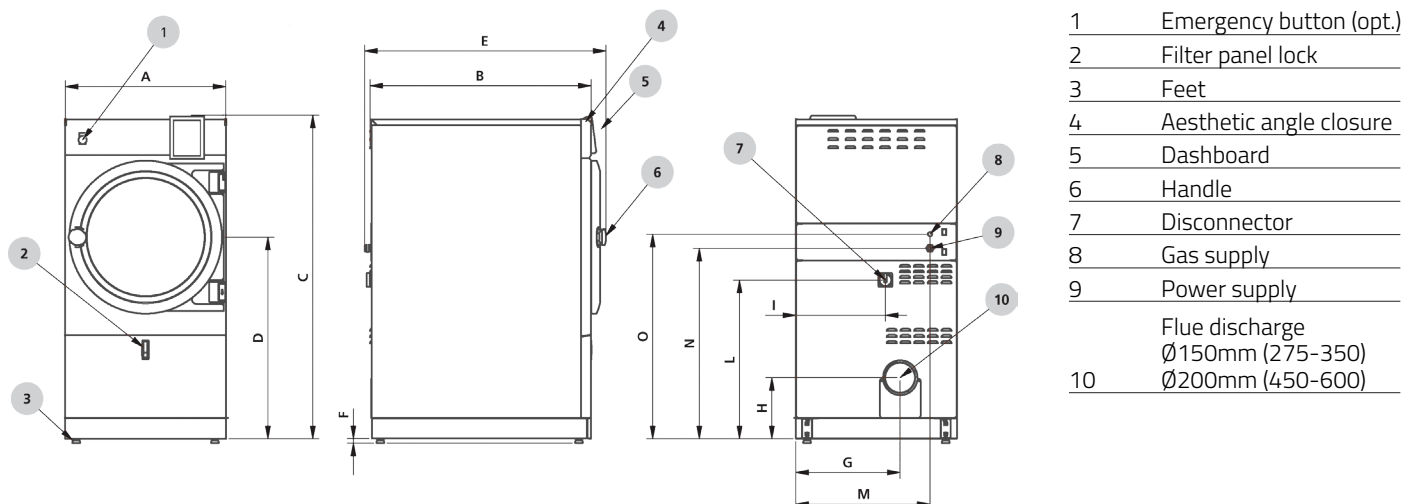

	A	B	C	D	E	F	G	H	I	L	M	N	O
GD275 (mm)	795	920	1590	1000	1030	25	515	300	442	780	563	938	1008
GD350 (mm)	795	1085	1590	1000	1195	25	515	300	442	780	563	938	1008
GD450 (mm)	970	990	1810	1090	1100	25	710	430	617	880	790	1030	1080
GD600 (mm)	970	1205	1810	1090	1315	25	710	430	617	880	790	1030	1080
	Width	Depth	Height										

## **Credits**

agenzia:  
consilia.it

grafica e art direction:  
Consilia.it

copy:  
Giovanna Cesarato

## **Grandimpianti I.L.E. Ali Group S.r.l. a Socio Unico**

Via Masiere 211/c  
32037 Sospirolo (BL) Italy

### **informations**

info@grandimpianti.com  
ph. +39 0437 848711  
fax +39 0437 879108

### **sales**

com@grandimpianti.com  
ph. +39 0437 848711

### **customer care**

tec@grandimpianti.com  
ph. +39 0437 848800



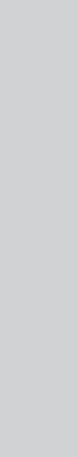
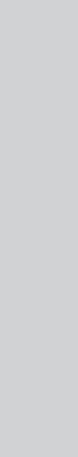

**Grandimpianti I.L.E. Ali Group S.r.l. a Socio Unico**  
via masiere, 211/c - 32037 sospiolo (BL) Italy  
ph. +39 0437 848 711 - fax +39 0437 879 108  
[www.grandimpianti.com](http://www.grandimpianti.com) - [info@grandimpianti.com](mailto:info@grandimpianti.com)



COMPANY WITH  
MANAGEMENT SYSTEM  
CERTIFIED BY DNV GL  
= ISO 9001 =  
- ISO 14001 -

an Ali Group Company



The Spirit of Excellence